



VOLANTÉ V1000

GENERAL SURGERY TABLE



BRINGING
VERSATILITY
TO THE OPERATING ROOM



PRODUCT
SPECIFICATIONS

Volanté V1000 Specifications

- Sleek, streamlined stainless-steel construction
- Powered operating table with 180° rotating top for general and specialty surgery
- 1,000 lbs. maximum patient weight¹
- Full-length radiolucent top
- Offset cylindrical column for superior imaging and access
- Optional battery back-up in the event of power failure
- Hand control activates/deactivates brakes, wheels and castors for stability and steering
- Head section is removable and added to leg section for superior imaging accessibility
- Pressure-relieving mattress²

Dimensions

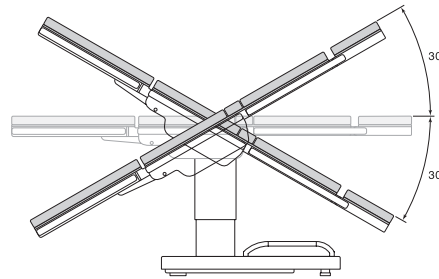
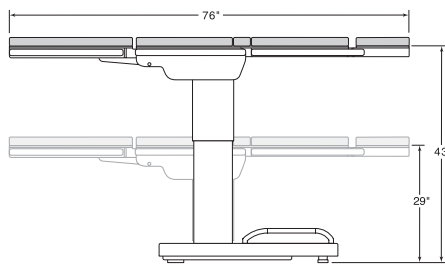

30° Trendelenburg
and Reverse Trendelenburg

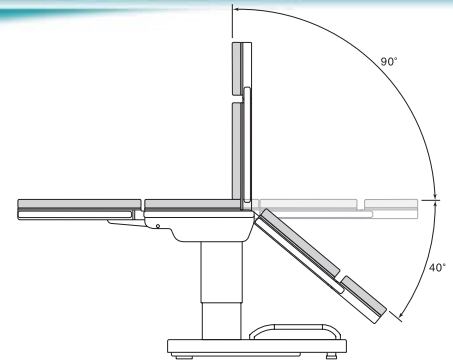

Back Up 90°
Back Down 40°

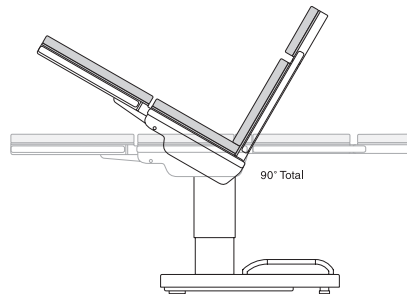

Reflex 90°

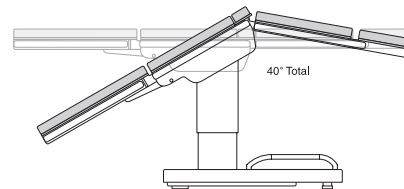

Flex 40°

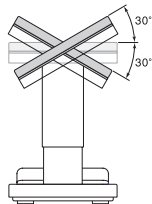

30° Lateral Tilt
Right & Left

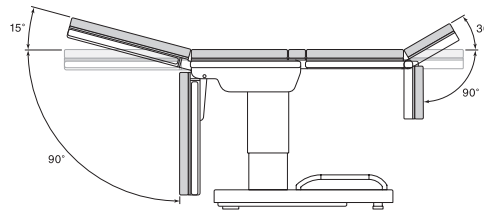

Head Up 30° Head Down 90°
Leg Up 15° Leg Down 90°

Table Top

Length:	76"
Width:	19.75"
Max. Height:	43"
Min. Height:	29"

Lift Capacity

1,000 lbs.

Articulation

800 lbs.

Lateral Tilt

30°

Trendelenburg

30°

Back Section

+ 90°
- 40°

Head Section

+ 30°
- 90°

Leg Section

+ 15°
- 90°

Table Rotation

180°

Self-Leveling Brakes

Powered

¹ See Instructions for Use (table positions and safe loading section)

² Includes 2" mattress



A member of the Medical Illumination International Group

5368 Kuhl Road • Erie, PA 16510-4703

(800) 663-1152 • (814) 899-4220

Fax: (814) 899-1410

www.nuvosurgical.com

NUVO, Inc. reserves the right to make changes without notice in design, specifications, and models. The only warranty NUVO, Inc. makes is the express written warranty extended on the sale or rental of its products.
© 2007 NUVO, Inc.
ALL RIGHTS RESERVED.